

902A

1200 x 470 x 1710 mm

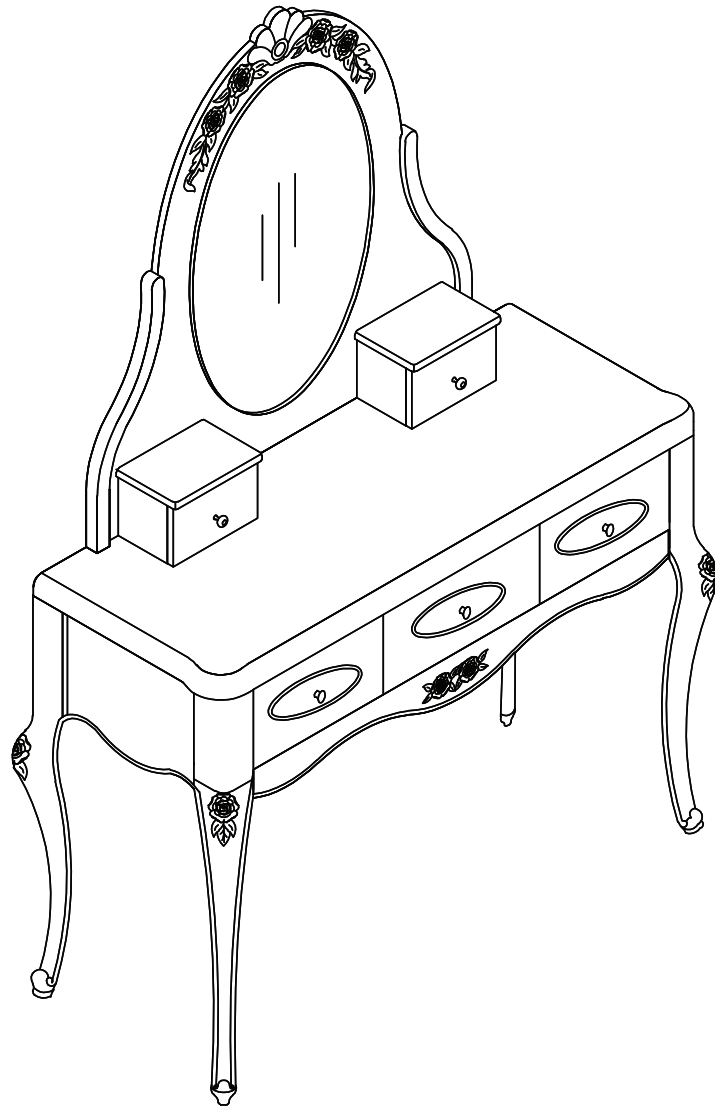

BEMONDI

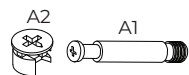
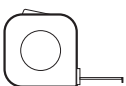
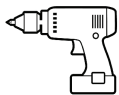
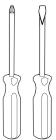
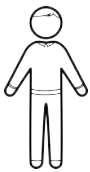
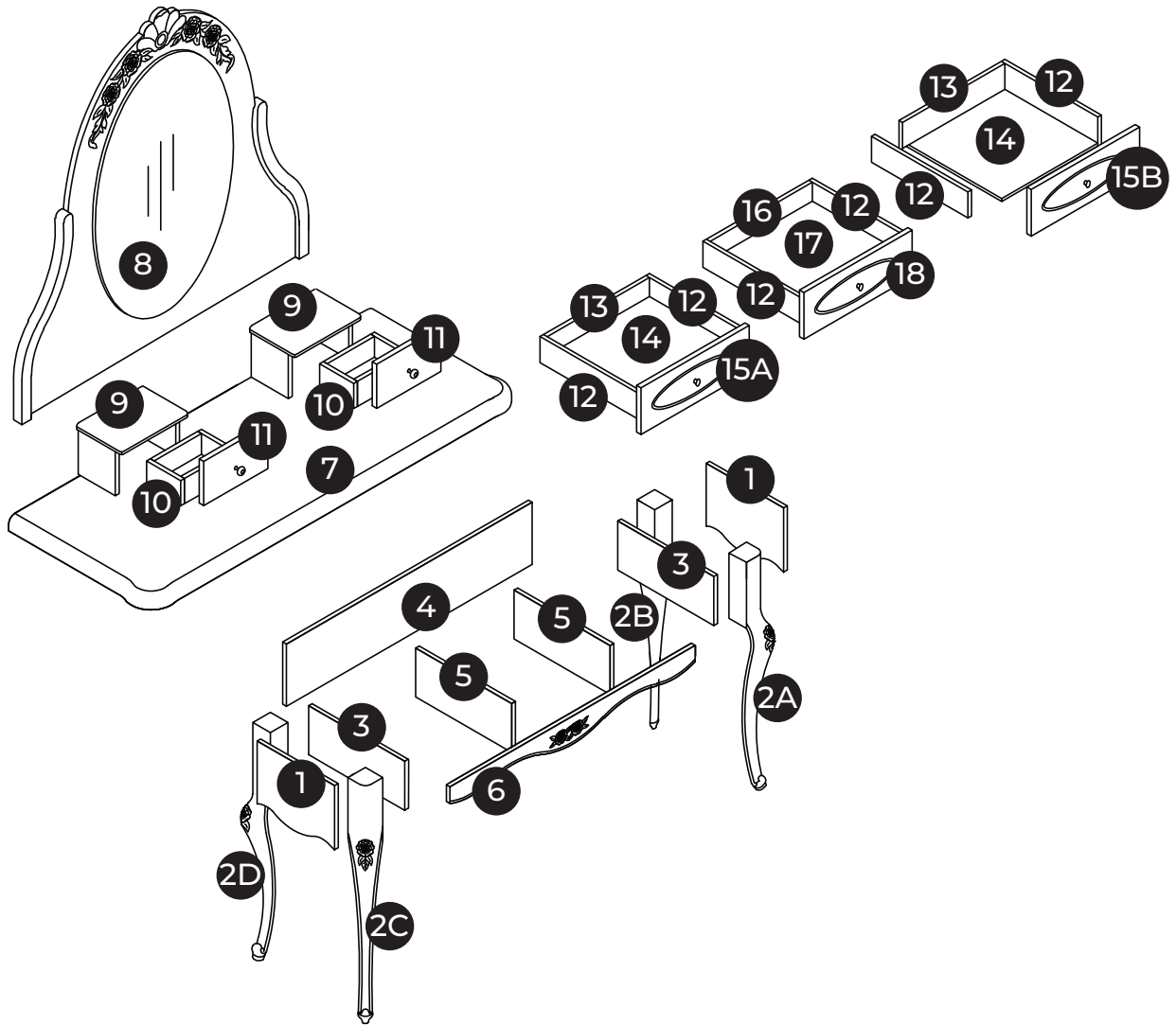

A x57
 Ø 15 mm



B x14
 Ø 8 x 30 mm



C x5



D x3
 Ø 4 x 25 mm



E x2
 Ø 4 x 18 mm



F x44
 Ø 3,5 x 15 mm

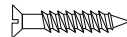

G x12
 Ø 3,5 x 35 mm

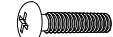

H x4
 Ø 6 x 20 mm

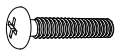

J x12
 Ø 6 x 25 mm

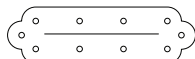

K x2
 250 x 40 mm

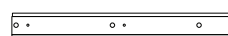

S x6
 350x35 mm

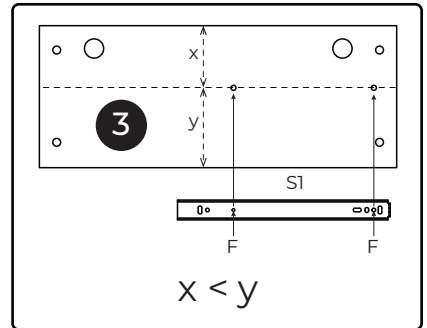
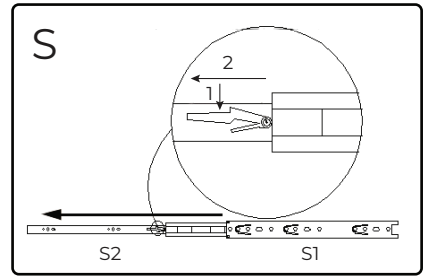
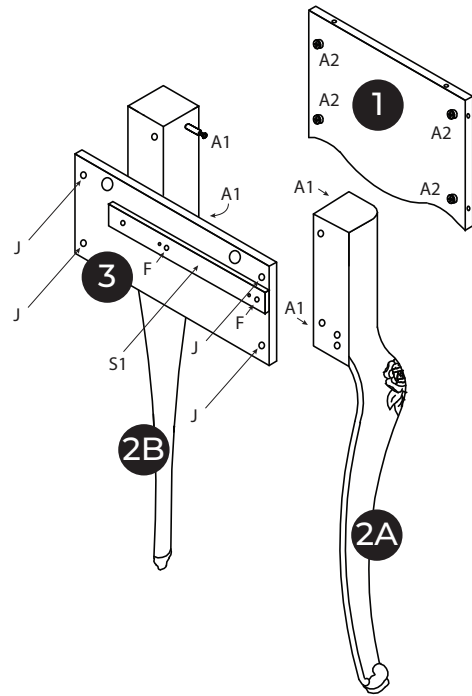
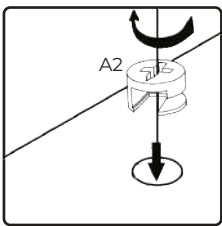
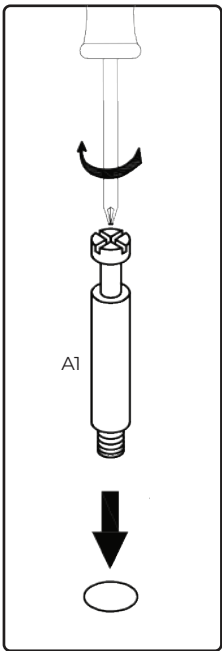

x2

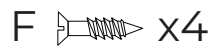
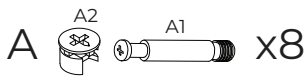

1

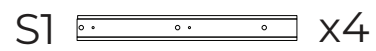
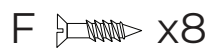
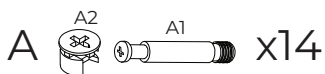
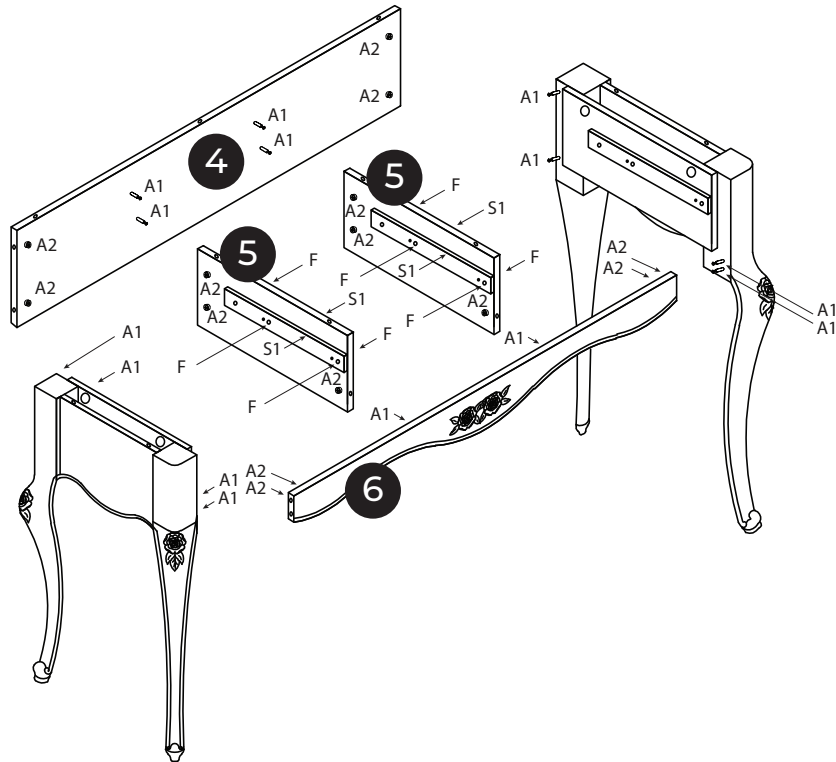

2

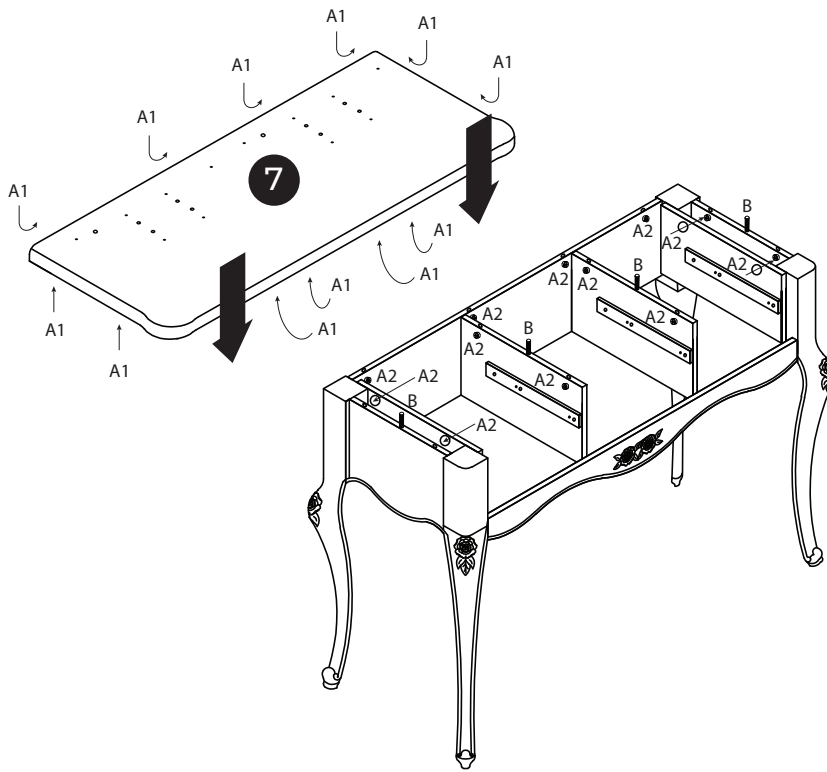

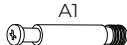
A   x12

B  x4

3

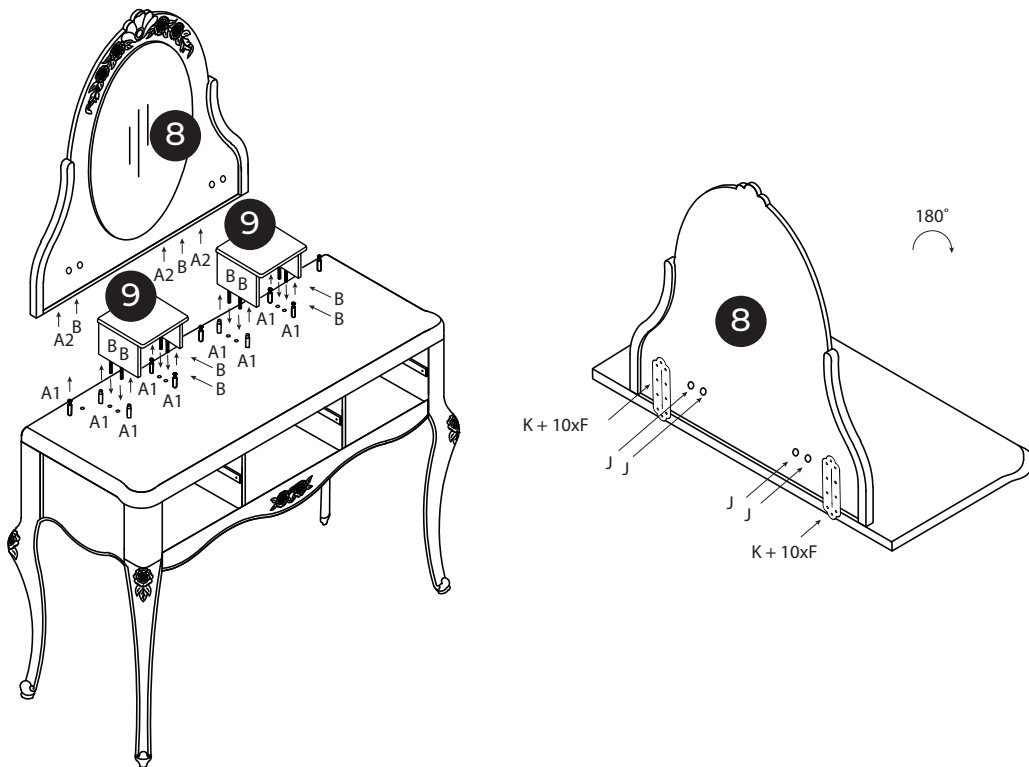

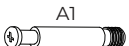
A   x11

B  x10

F  x20

J  x4

K  x2

4

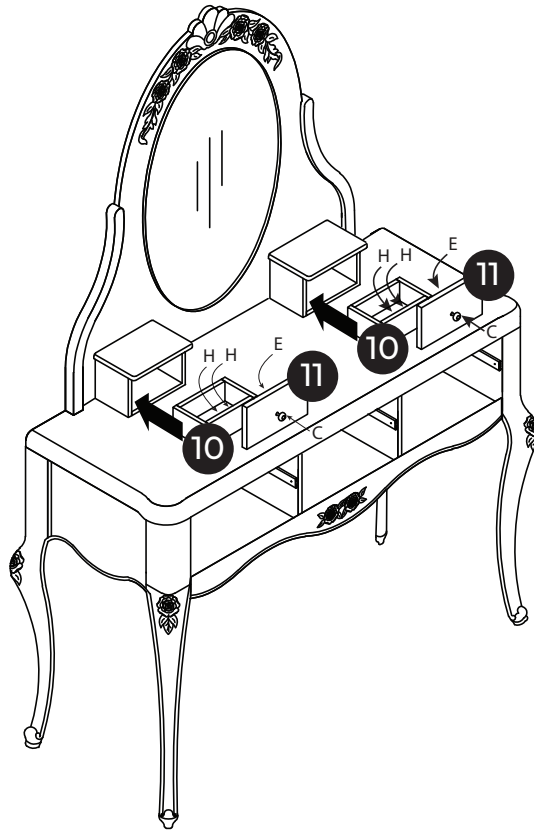

C  x2

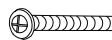
E  x2

H  x4

5

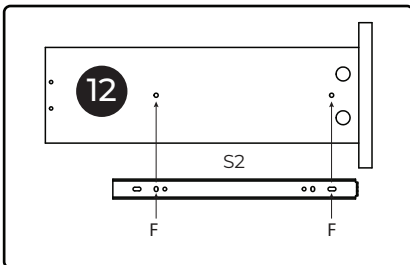

x6

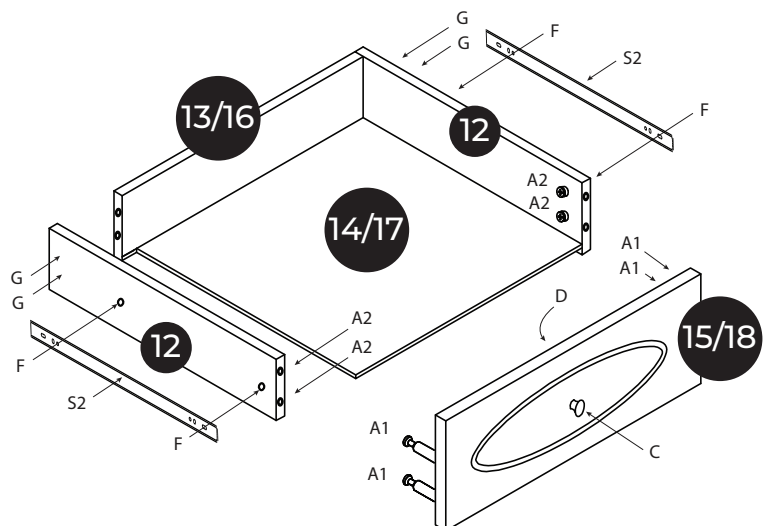
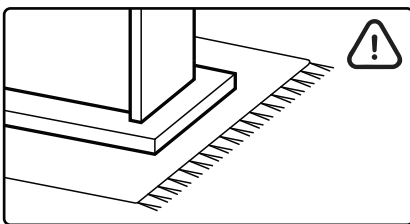
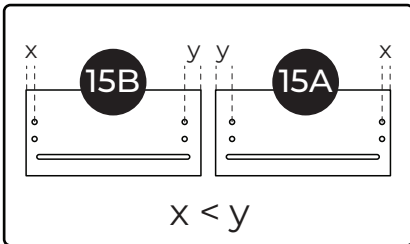

x3

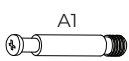
A   x12

C  x3

D  x3

F  x12

G  x12

S2  x6

6

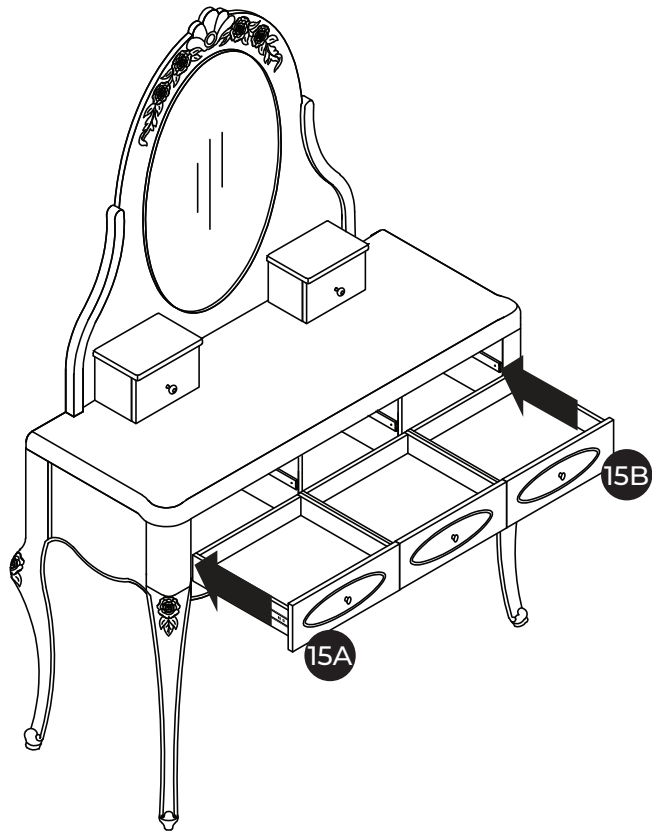

7

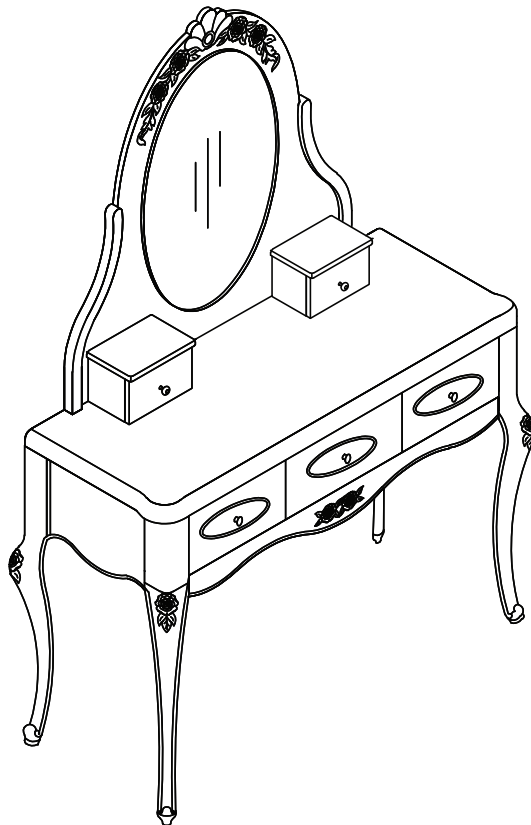

8